







## ALCOR - Mirrors with LED light



-  IP44
-  Low consumption. Led Samsung.
-  Standard CE
-  5 years guarantee
-  Work lighting
- 

### Technical Characteristics

	600	700	800	900	1000	1200
Kelvin	5700 (cool light)					
Lúmenes	410	690	750	780	820	860
Wattios	6+21		10+21		12+32	
Anticorrosion	No					
Energy efficiency	E		D		E	
Glass thickness	4 mm					
CRI	>90					
Useful life	5000 h					

### Product dimensions

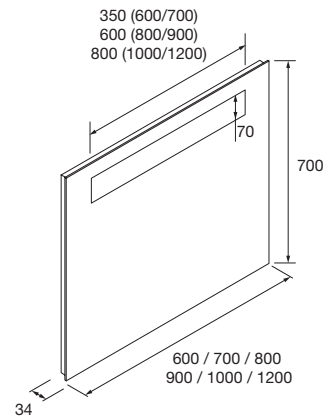

### Packaging dimensions and weight

	600	700	800	900	1000	1200
Lenght (mm)	685	785	885	985	1085	1285
Depth (mm)	75					
Height (mm)	765					
Net weight (kg)	4.05	4.9	5.35	5.9	6.9	7.7
Gross weight (kg)	4.85	5.06	6.35	6.9	7.9	8.95

### Installation dimensions

