

- E INSTRUCCIONES DE MONTAJE**
ADVERTENCIA: Para evitar cualquier riesgo de vuelco, este mueble debe fijarse a la pared utilizando los medios de sujeción adecuados al soporte.
- EN INSTALLATION INSTRUCTIONS**
WARNING: To avoid any risk of tipping over, this furniture must be fixed to the wall using the appropriate fixing system
- D MONTAGEANLEITUNG**
WARNUNG: Um die Gefahr des Umkippens zu vermeiden, müssen diese Möbel mit den entsprechenden Befestigungsmitteln am Träger und der Wand befestigt werden.
- FR INSTRUCTIONS DE MONTAGE**
AVERTISSEMENT : Pour éviter tout risque de basculement, ce meuble doit être fixé au mur en utilisant des moyens de fixations adaptés au support.
- P INSTRUÇÕES DE MONTAGEM**
AVISO: Para evitar qualquer risco de tombamento, esse móvel deve ser fixado na parede usando os meios de fixação adequados ao suporte.
- I INSTRUZIONI DI MONTAGGIO**
ATTENZIONE: per evitare qualsiasi rischio di ribaltamento, questo mobile deve essere fissato al muro utilizzando dispositivi di fissaggio adeguati al supporto.

1

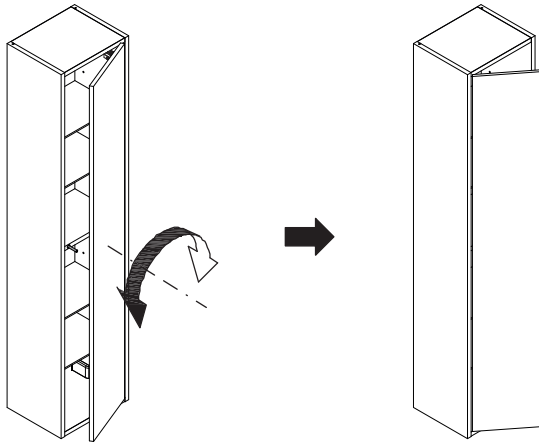

2

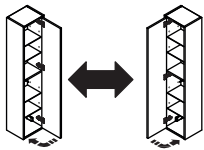
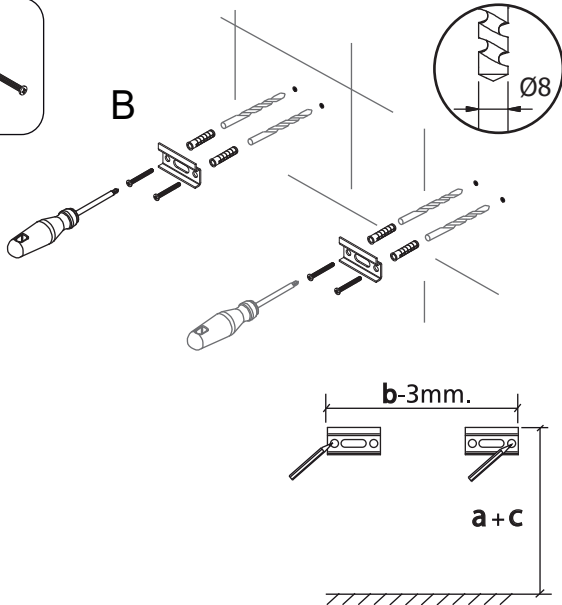
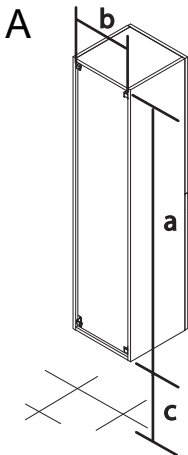
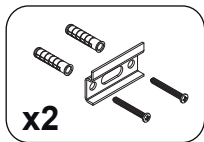

3

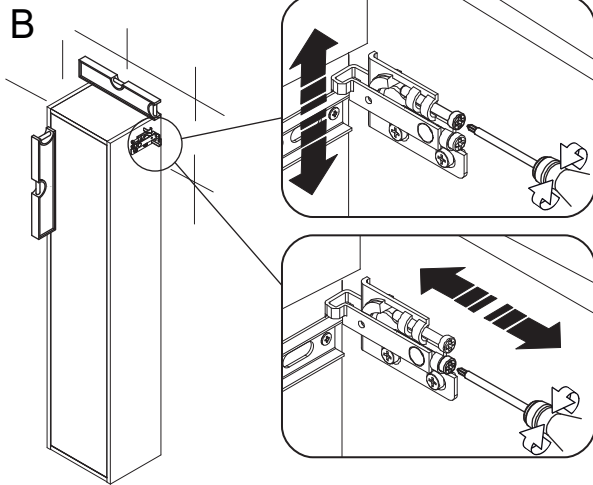
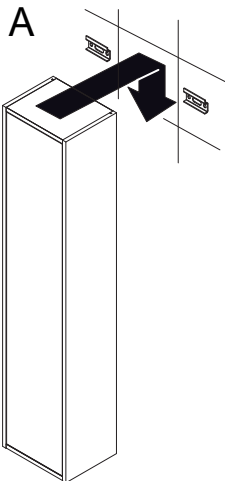

*

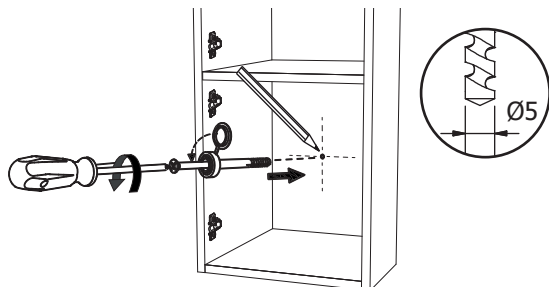
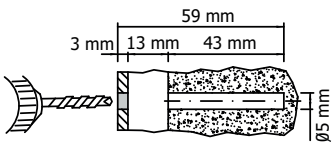
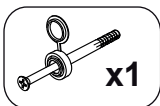

4

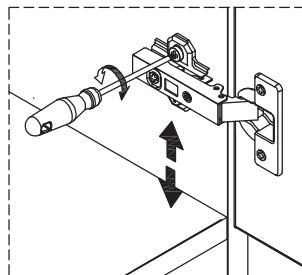
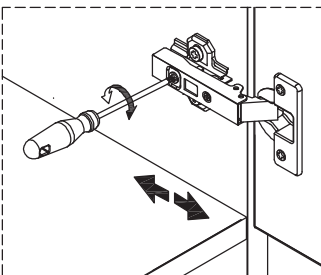
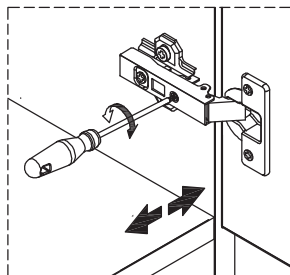
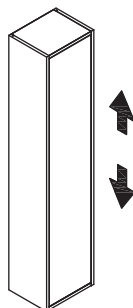
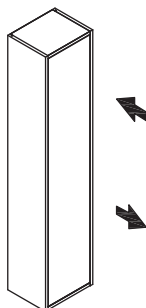
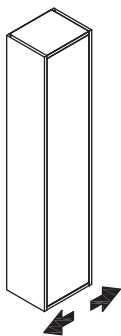

*

